

TOSHIBA



Portable Printer

B-FP3D SERIES

Owner's Manual



CE Compliance (for EU only)

This product complies with the requirements of EMC and R&TTE Directives including their amendments. CE marking is the responsibility of TOSHIBA TEC GERMANY IMAGING SYSTEMS GmbH, Carl-Schurz-Str. 7, 41460 Neuss, Germany.
For a copy of the related CE Declaration of Conformity, please contact your dealer or TOSHIBA TEC.

FCC Notice

This equipment has been tested and found to comply with the limits for a Class B digital device, pursuant to Part 15 of the FCC Rules. These limits are designed to provide reasonable protection against harmful interference in a residential installation. This equipment generates, uses, and can radiate radio frequency energy and, if not installed and used in accordance with the instructions, may cause harmful interference to radio communications. However, there is no guarantee that interference will not occur in a particular installation. If this equipment does cause harmful interference to radio or television reception, which can be determined by turning the equipment off and on, the user is encouraged to try to correct the interference by one or more of the following measures:

- Reorient or relocate the receiving antenna.
- Increase the separation between the equipment and receiver.
- Connect the equipment into an outlet on a circuit different from that to which the receiver is connected.
- Consult the dealer or an experienced radio/TV technician for help.

Changes or modification not expressly approved by manufacturer for compliance could void the user's authority to operate the equipment.

"This Class B digital apparatus meets all requirements of the Canadian Interference-Causing Equipment Regulations."

(for CANADA only)

Some types of this product are equipped with a wireless communication device, such as, BT800 and GS2100MIP. Please be sure to read the enclosed Precautions for Handling of Wireless Communication Devices before using this product.

Note:

When you purchase interface cables on the market, shielded cables must be chosen and used.



This product is designed for commercial usage and is not consumer product.

The following information is for EU-member states only:

Disposal of batteries and/or accumulators

(based on EU-Directive 2006/66/EC,

Directive on batteries and accumulators and waste batteries and accumulators)



The use of the symbol indicates that batteries and/or accumulators may not be disposed as unsorted municipal waste and has to be collected separately.

By ensuring that batteries and/or accumulators are disposed of correctly, you will help prevent potential negative consequences for the environmental and human health, which could otherwise be caused by inappropriate waste handling of this product.

For more detailed information about the take-back and recycling of batteries and/or accumulators, please contact your supplier where you purchased this product.

California Proposition 65: USA-California only

⚠ WARNING

This product can expose you to Phthalate[s] known to the State of California to cause cancer, birth defects or other reproductive harm. For more information go to

www.P65Warnings.ca.gov/product

TOSHIBA TEC CORPORATION

© 2016 TOSHIBA TEC CORPORATION All Rights Reserved
1-11-1, Osaki, Shinagawa-ku, Tokyo 141-8562, JAPAN

E PRINTED IN INDONESIA
EO1-33109A
SPTM-0273

CAUTION!

1. Only use TOSHIBA TEC battery packs designed and manufactured for use with the specific printer model. The battery used in this device may present a risk of fire or chemical burn if mistreated. Do not disassemble, heat above +50degC, or incinerate. Replace battery with B-FP3D series only. There is a risk of fire or explosion if the battery is replaced by an incorrect type.

B-FP3D-GS30-QM-R } B-FP803-BT-R B-FP3D-GH30-QM-R }
B-FP3D-GS40-QM-R } B-FP3D-GH40-QM-R } B-FP803-BTH-QM-R

2. Dispose of used battery promptly. Keep away from children. Do not disassemble and do not dispose of in fire.
3. When an external power source such as an AC adapter is connected to the printer, DO NOT use any device other than an exclusive one.

AC adapter: B-EP800-AC-QM-R (Model: FSP065-REBN2)
Cigarette lighter adapter: B-EP802-DC12-QM-R
DC adapter: B-EP800-DC48-QM-R

The following information is for EU-member states only:

Disposal of products

(based on EU-Directive 2012/19/EU

Directive on Waste electrical and electronic equipment – WEEE)



The use of the symbol indicates that this product may not be disposed as unsorted municipal waste and has to be collected separately. Integrated batteries and accumulators can be disposed of with the product. They will be separated at the recycling centers.

The black bar indicates that the product was placed on the market after August 13, 2005.

By ensuring this product is disposed of correctly, you will help prevent potential negative consequences for the environmental and human health, which could otherwise be caused by inappropriate waste handling of this product.

For more detailed information about the take-back and recycling of this product, please contact your

For Argentina

La siguiente información es solo para Argentina:



El uso de este símbolo indica que este producto no puede ser tratado como residuos domésticos.

Asegúrese que este producto se deseché correctamente, Usted ayudara a evitar posibles consecuencias negativas para el medio ambiente y la salud humana, que podrían derivarse de la incorrecta manipulación de este producto.

Para mas información sobre el reciclaje de este producto, consulte con nuestro su distribuidor donde adquirió el producto.

For Taiwan

NCC 警語

低功率電波輻射性電機管理辦法第十二條經型式認證合格之低功率射頻電機，非經許可，公司、商號或使用者均不得擅自變更頻率、加大功率或變更原設計之特性及功能。第十四條低功率射頻電機之使用不得影響飛航安全及干擾合法通信；經發現有干擾現象時，應立即停用，並改善至無干擾時方得繼續使用。前項合法通信，指依電信規定作業之無線電信。低功率射頻電機須忍受合法通信或工業、科學及醫療用電波輻射性電機設備之干擾。

For Mexico

- La operación de este equipo está sujeta a las siguientes dos condiciones:

(1) es posible que este equipo o dispositivo no cause interferencia perjudicial y

(2) este equipo o dispositivo debe aceptar cualquier interferencia, incluyendo la que pueda causar su operación no deseada

For Korea

인명안전과 관련된 서비스는 할 수 없음

이 기기는 가정용(B 급) 전자파적합기기로서 주로 가정에서 사용하는 것을 목적으로 하며, 모든 지역에서 사용할 수 있습니다

For Singapore

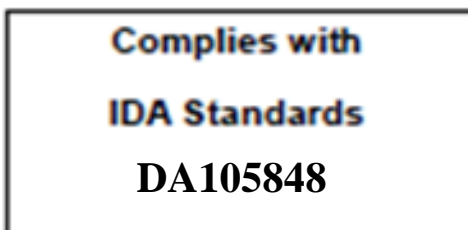

Precautions for Handling of Wireless Communication Devices
Bluetooth® Module: BT800 (GS30/GH30 model)
Wireless LAN Module: GS2100MIP (GS40/GH40 model)

Trade Mark

Bluetooth is a registered trademark owned by Bluetooth SIG, Inc. and used by TOSHIBA TEC CORPORATION under license.

Cautions

General

For all countries and areas

This product is a wireless communication device, and the use of this product is restricted to the following countries or areas. If the product is used in the countries or areas other than the following, you may be punished according to the laws of those countries or areas.

USA, Canada, Austria, Belgium, Bulgaria, Croatia, Cyprus, Czech Republic, Denmark, Estonia, Finland, France, Germany, Greece, Hungary, Ireland, Italy, Latvia, Lithuania, Luxembourg, Malta, Netherlands, Poland, Portugal, Romania, Slovakia, Slovenia, Spain, Sweden, United Kingdom, Switzerland, Norway, Iceland, Liechtenstein, Australia, New Zealand

For Europe

For Bluetooth and Wireless LAN:

Hereby, TOSHIBA TEC CORPORATION declares that the BT800 and GS2100MIP are in compliance with the essential requirements and other relevant provisions of Directive 2014/53/EU. This equipment uses a radio frequency band that has not been harmonized throughout all EU and EFTA countries, and can be used EU and EFTA countries.

For USA

This device complies with Part 15 of the FCC Rules. Operation is subject to the following two conditions:

- (1) this device may not cause harmful interference, and
- (2) this device must accept any interference received, including interference that may cause undesired operation.

Changes or modification not expressly approved by manufacturer for compliance could void the user's authority to operate the equipment.

For Canada

Operation is subject to the following two conditions:

- (1) this device may not cause interference, and
- (2) this device must accept any interference, including interference that may cause undesired operation of the device.

To prevent radio interference to the licensed service, this device is intended to be operated indoors and away from windows to provide maximum shielding. Equipment that is installed outdoors is subject to licensing.

For Taiwan

Caution

根據低功率電波輻射性電機管理辦法

Without permission, any company, firm or user shall not alter the frequency, increase the power, or change the characteristics and functions of the original design of the certified lower power frequency electric machinery.

The application of low power frequency electric machineries shall not affect the navigation safety nor interfere a legal communication, if an interference is found, the service will be suspended until improvement is made and the interference no longer exists.

For safety

Do not use this product in locations where use may be forbidden, for example, in an aeroplane or a hospital. If you do not know the forbidden areas, please refer to and follow the airline company or medical institution guidelines. Flight instruments or medical equipment may be affected, causing a serious accident.

Since this product uses extremely low power compared with mobile phones, it cannot possibly interfere the pacemakers and defibrillators. However, if the use of this product should be likely to have affected the pacemaker or defibrillator, immediately stop using the product and contact your TOSHIBA TEC sales agent.

Do not disassemble, modify, or repair the product. Doing so may cause injury. Also, modification is against the Laws and Regulations for Radio Equipment. Please ask your TOSHIBA TEC sales agent for repair.

Precaution in use

This product communicates with other devices by radio. Depending on the installation location, orientation, environment, etc., its communication performance may deteriorate or devices installed near by may be affected.

Keep away from microwave devices.

Communication performance may deteriorate or a communication error may occur due to radio interference emitted from the microwave device.

Since the Bluetooth and wireless LAN use the same radio frequency band, each radio wave may interfere with each other when they are used at the same time, causing a deterioration of communication performance or a disconnection of network. If there is any problem with connection, please stop using either Bluetooth or wireless LAN.

Do not use the product on a metal table or near a metal object.
Communication performance may be deteriorated.

BT800 Specification

Bluetooth version	V4.0 Dual Mode
Frequency	2.402 to 2.480 GHz
Maximum Transmit	Class 1
Power	+8 dBm from antenna "
Receive Sensitivity	-89 dBm
Data Rates	Up to 3 Mbps (over the air)
Communication distance	3m/360deg (For FP3D specification)
Certification (Module)	US/FCC: SQGBT800, CANADA/IC: 3147A-BT800 (Put on "Contains FCC ID: SQG-BT800" in certification label) Europe: RE 2014/53/EU
Antenna specification	PN: AT3216-B2R7HAA, Mfg.: ACX, Type Ceramic, Gain: 0.5(dBi)

GS2100MIP Specification

Standard	IEEE802.11 b / g / n
Frequency	USA: 2,412 to 2,462 MHz ; EUROPE:2,412 to 2,472 MHz
Spacing	5 MHz
Channel:	USA:1 to 11 ch ; EUROPE:1 to 13 ch
Antenna	PCB Trace antenna (built-in module) @2.0dBi
Communication speed/ Modulation	IEEE802.11b : CCK modulation rates of 5.5 and 11 Mbps; DSSS modulation for data rate of 1 and 2 Mbps IEEE802.11g : OFDM modulation rates of 6, 9, 12, 18, 24, 36, 48 and 54 Mb/s IEEE802.11n : 1x1 single stream, 20MHz channels (1x1 HT20), 400/800ns GI, MCS0-7 Data rates of 7.2, 14.4, 21.7, 28.9, 43.3, 57.8, 65.0, 72.2 Mbps
Receive Sensitivity	802.11b -93dBm ; 802.11g -74dBm ; 802.11n -71dBm
Transmission output	802.11b Typ. 17 dBm (50.12mW) 802.11g Typ. 14 dBm (25.12mW) 802.11n Typ. 12 dBm (15.85mW)

CAUTION!

1. To avoid injury, be careful not to catch or jam your fingers while opening or closing the cover.
2. Do not touch moving parts. To reduce the risk that fingers, jewelry, clothing, etc., be drawn into the moving parts, turn off the power switch to stop movement.

Safety Summary

Personal safety in handling or maintaining the equipment is extremely important. Warnings and Cautions necessary for safe handling are included in this manual. All warnings and cautions contained in this manual and written inside or outside of the printer should be read and understood before handling or maintaining the equipment.

Do not attempt to effect repairs to this equipment. If a fault occurs that cannot be rectified using the procedures described in this manual, turn off the power, then contact your authorised TOSHIBA TEC representative for assistance.

Safety Precautions

This Owner's Manual and the products (machines) which you have purchased contain indications which should be observed in order to use the machines safely and prevent harm to yourself and others and damage to property. The meanings of these indications and symbols are given below.

Read these indications and become familiar with their contents before reading this Owner's Manual.

Precautions

The following precautions will help to ensure that this machine will continue to function correctly.

- (1) Try to avoid locations that have the following adverse conditions:
 - *Temperatures out of the specification
 - *High Humidity
 - *Direct sunlight
 - *Excessive vibration
- (2) The cover should be cleaned by wiping with a dry cloth or a cloth slightly dampened with a mild detergent solution. NEVER USE THINNER OR ANY OTHER VOLATILE SOLVENT on the plastic covers.
- (3) USE ONLY TOSHIBA TEC SPECIFIED media.
- (4) DO NOT STORE the media where it might be exposed to direct sunlight, high temperatures, high humidity, dust, or gas.
- (5) Any data stored in the memory of the printer could be lost during a printer fault.
- (6) DO NOT open the top cover and battery cover during operation. Doing so will stop printer operation.
- (7) DO NOT scratch the surface of printed labels or receipt with a sharp object.
- (8) Be sure to use a shielded interface cable.

CAUTION!

1. This manual may not be copied in whole or in part without the prior written permission of TOSHIBA TEC.
2. The contents of this manual may be changed without notification.
3. Please refer to your local Authorised Service representative with regard to any queries you may have in this manual.

**WARNING**

This indicates that there is the risk of death or serious injury if the machines are handled improperly or contrary to this indication.

- If water or any other liquid enters the machine, turn off the power. Continuous use of the machine under such conditions may cause fire or electric shock.
- If the enclosure is damaged when dropped or subject to shock, turn off the power. Continuous use of the machine under such conditions may cause fire or electric shock.
- Avoid continuous exposure to direct sunlight or high temperature as this may cause fire.
- Do not remove covers or modify the machine by yourself. Doing so may cause fire or electric shock.
- Avoid water, operation with wet hands or cleaning with a moistened cloth. Failure to do this may cause fire or electric shock.
- Do not wipe the machine with a cloth moistened with thinner or other volatile solvent as this may cause fire or electric shock.
- DO NOT USE a spray cleaner containing flammable gas for cleaning this product, as this may cause a fire.
- Use the specified battery only. Failure to do this may cause fire or electric shock.
- Danger of explosion if the battery is incorrectly replaced. Replace the battery only with a TOSHIBA TEC Corporation, Battery Pack Model B-FP803-BT-R 7.4V 2500mAh Li-ion or B-FP803-BTH-QM-R 7.2V 2500mAh Li-ion. Discard used batteries according to the manufacturer's instruction.
- Do not disassemble and modify the battery because it has a protection unit in it. Doing so may break the protection unit, causing the battery to heat up, burst or burn.
- If the battery gets wet, dry it completely. Using a wet battery may cause fire or electric shock.

- Be aware of the following precautions when using batteries. Otherwise they could heat up, burst or burn.
 - Do not throw the battery into fire or heat it with a microwave or oven, etc.
 - Do not load the battery with the electrodes reversed.
 - Do not connect the electrodes with metal objects like wire. Do not carry or store the battery along with metal objects such as necklaces, hairpins, etc.
 - Do not stick a needle into, hammer, step on, or drop the battery.
 - Do not solder the battery.
 - Do not leave the battery where the temperature is more than 50°centigrade, such as inside a car or in direct sunlight.

**CAUTION**

This indicates that there is the risk of personal injury or damage to objects if the machines are improperly handled contrary to this indication.

- Keep away from flame or other sources of heat. Failure to do this may cause fire or machine failure.
- Do not drop or shock the machine as this may cause machine failure.
- During lightning, turn off and keep away from the machine because of danger of electric shock and machine failure.
- Avoid locations subject to rapid change in temperature as this causes condensation, causing electric shock or machine failure.
- Do not damage the print head, platen or strip roller with a sharp object. Doing so may cause machine failure.
- Do not touch or contact the print head element with a hard object. Doing so may cause machine failure.
- Use the specified media only. Failure to do this may cause machine failure.
- Be sure to turn off the machine before replacing the battery, or machine failure may occur.
- Do not charge the battery near flame or under direct sunlight. High temperature may activate or damage the protection unit of the battery, disabling the electric charge or causing it to overheat, burst, or burn.
- Unload the battery when the machine will not be used for a longtime. Failure to do this may cause machine failure.
- Keep the battery away from flame, a heat source or other locations subject to high temperature. Failure to do this may cause it to over heat or burn.
- Do not force the battery into the machine or battery charger. Doing so may cause the battery to overheat, burst or burn. Check for the correct electrode.
- Do not connect the battery to a power outlet or a car cigarette lighter jack as this may cause the battery to overheat, burst or burn.
- Because the B-FP803-BT-R and the B-FP803-BTH-QM-R Series battery is exclusively for the B-FP3D-GS and the B-FP3D-GH Series printer, respectively, do not use the battery in other machines. Doing so may damage the battery or affect the performance and life of the battery.



警告

下面的指示表示如果對機器進行不恰當的與指示相違背的操作時，將可能引起嚴重傷害或者死亡的危

- 如果水或其他任何液體進入機器，請關閉電源。如果在這種情況下連續使用機器，可能會導致起火或觸電。
- 如果機器外殼損壞或跌落，或受到的衝擊時，請關閉電源。如果在這種情況下連續使用機器，可能會導致起火或觸電。
- 避免連續受陽光直接照射或高溫，因為這可能會導致火災。
- 不要擅自拆除封蓋或改裝機器。這樣做可能會導致起火或觸電。
- 避免機器與水接觸，或使用濕手操作，或使用濕布清潔機身。否則可能會導致起火或觸電。
- 不要使用沾有稀釋劑或其它揮發性溶劑的布清潔機器，因為這可能會導致起火或觸電。
- 請嚴禁使用噴霧式清潔劑，包括可燃氣體對機器進行清潔，否則將引起火災。
- 請僅使用指定型號的電池。否則可能會導致起火或觸電。
- 如果不按照正確的方式更換電池，可能會發生爆炸。請務必使用東芝泰格公司指定型號的電池 B-FP803-BT-R 7.4 伏 2500 毫安的鋰離子或 B-FP803-BTH-QM-R 7.2 伏 2500 毫安的鋰離子電池。請根據製造商的指示丟棄廢舊電池。
- 不要擅自拆開和改裝電池，因為它有一個保護部件。否則可能會破壞這個保護部件，並導致電池的升溫，爆裂或燃燒。
- 如果電池受潮，請將其完全晾乾。使用濕電池可能導致起火或觸電。
- 當使用電池時，請注意以下的預防措施。否則可能導致電池的升溫，爆裂或燃燒。
 - 不要把電池扔進火中，或使用微波爐或烤箱等進行加熱。
 - 不要安裝電池時電極逆轉。
 - 不要將電池的電極與金屬物體連接，比如電線。不要將電池與金屬物體一起攜帶或儲存，如項鍊，髮夾等等。
 - 不要將針插入電池，不要使用錘子敲擊電池，不要踩踏電池，不要摔擊電池。
 - 不要銲接電池。
 - 不要將電池放置在溫度超過攝氏 50 度的環境中，如在車內或陽光直接照射。



注意

這個符號表示，如果對此設備作不恰當的與提示相違背的操作，將可能引起嚴重傷害或者有死亡的危

- 使用機器時遠離火焰或其他熱源。否則可能會導致火災或機械故障。
- 不要跌落或震動機器，因為這可能會導致機械故障。
- 在閃電時，請關閉並遠離機器，否則可能會發生觸電的危險和機械故障。
- 不要在溫度快速變化的環境中使用機器，因為凝結會造成觸電或機械故障。
- 不要使用利器損害打印機的打印頭，壓板或滾軸。否則可能會造成機械故障。
- 不要使用堅硬的物體接觸或連接打印頭。否則可能會造成機械故障。
- 請僅使用指定的介質。否則可能會造成機械故障。
- 請務必在更換電池之前關閉機器，否則可能會造成機械故障。
- 給電池充電時，不要靠近火焰或陽光直接照射的地方。否則高溫可能會刺激或損害電池的保護部件，進而導致無法充電，或造成過熱，爆裂，或燃燒。
- 如果機器將長期擱置不用，請卸下電池。否則可能會造成機械故障。
- 請保持電池遠離火焰，熱源或其他高溫地點。否則可能會造成電池過熱或燃燒。
- 不要用力使將電池裝入機器或電池充電器。否則可能會導致電池過熱，爆裂或燃燒。安裝電池時要確保電極正確連接。
- 不要將電池連接至電源插座或汽車的打火機口，否則可能會導致電池過熱，爆裂或燃燒。
- 因為 B-FP803-BT-R 和 B-FP803-BTH-QM-R 系列的電池分別是 B-FP3D-GS 和 B-FP3D-GH 系列打印機的專用電池，所以請不要在其他機器上使用該電池。否則可能會損壞電池或影響電池的工作表現和壽命。

Part Names

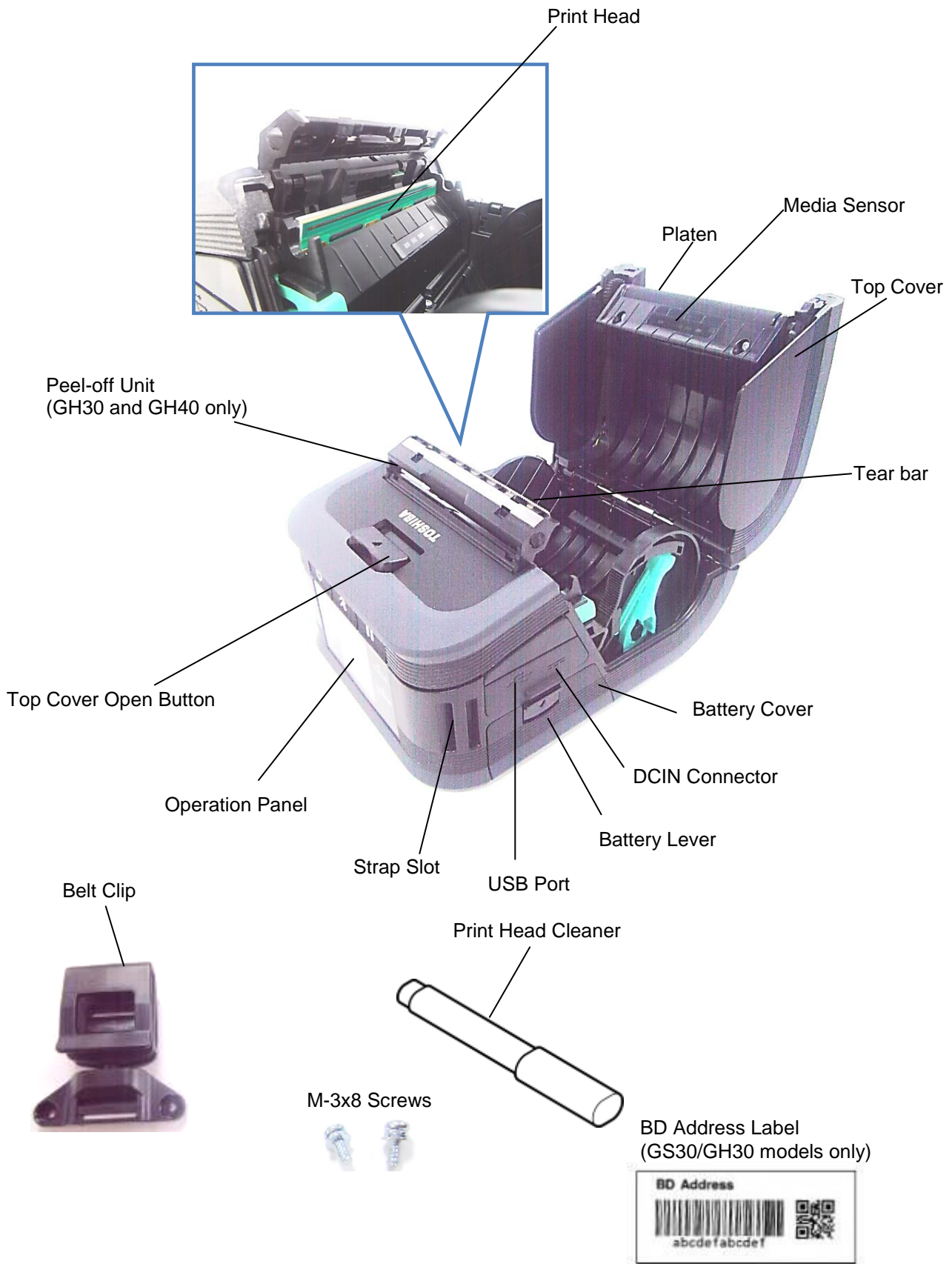

Operation Panel Functions

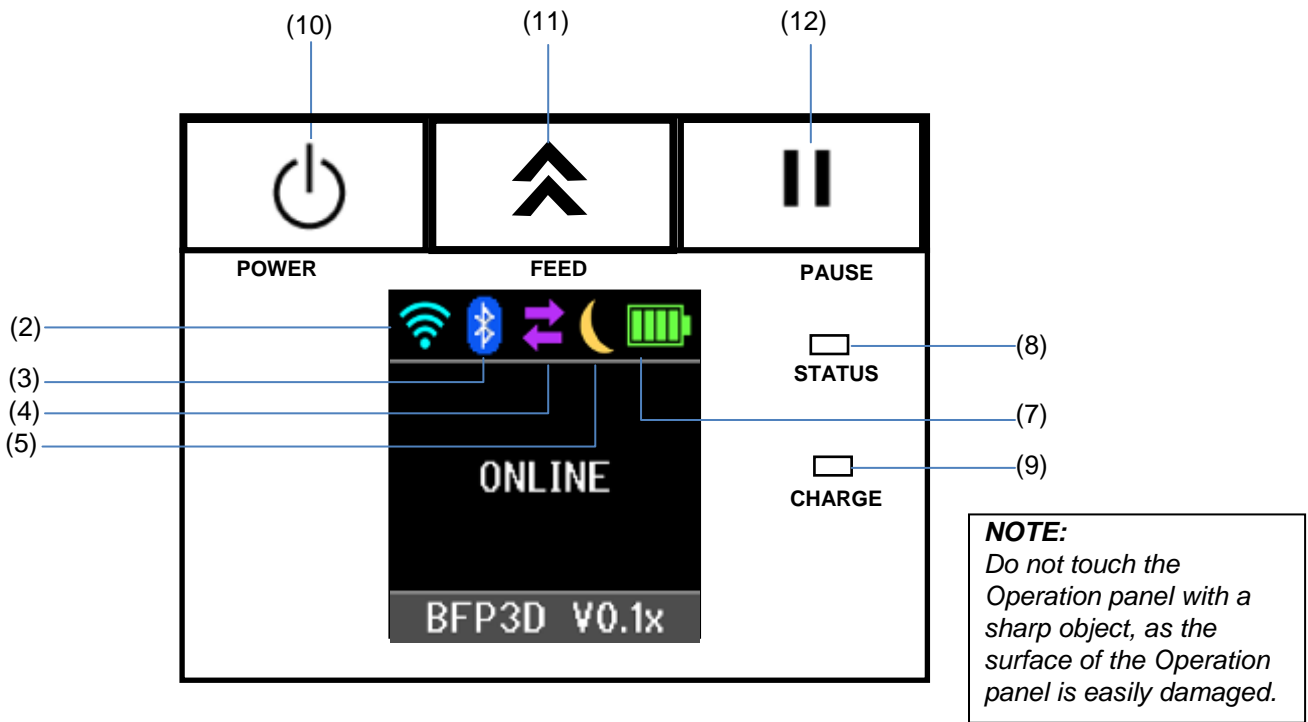

No.	Name/Icon	Function/Usage	
(1)	Liquid Crystal Display	Icons indicating the printer statuses, such as the radio intensity, battery level, etc. are displayed. Printer status is indicated in alphanumerals or symbols.	
	LCD Message	ON LINE	The printer is ready for an issue command from the host.
		PAUSE	The printer is in pause state. When the printer is paused during printing, the number of unprinted labels is displayed.
		COVER OPEN	The top cover is open.
		LBL PRESENT ****	The printer is waiting for the printed label to be removed from the media outlet. **** indicates the number of unprinted labels.
		WAITING(XXXX)	The printer is waiting for a recovery of the battery voltage or temperature decrease of the print head or motor.
(2)	WLAN Signal strength	Indicates the WLAN intensity in 4 levels	
(3)	Bluetooth	Bluetooth Connected	Indicates a Bluetooth connection status
		Bluetooth Not connected	
(4)	Transmission	Data receive by the printer	Indicates data transmission status.
		Data send to the host	
(5)	Sleep	Displayed while the printer is in the power save mode.	

(6)	Error	 Displayed when an error occurs on the printer.
(7)	Battery level	Indicates the battery level in 5 levels.
(8)	STATUS lamp	Lights or blinks in green, red, or orange to indicate the printer status. <ul style="list-style-type: none"> • Lights up in green: Normal state • Lights up in orange: Low-battery warning state (Operable) • Lights up in red: Low-battery state • Blinks in green or orange: Communicating or internal processing is in progress or a printed label is waiting to be removed. • Blinks in red: Error state
(9)	CHARGE lamp	Lights up in orange while the battery pack is charging and goes out when the battery charge is completed.
(10)	[POWER] button	Turns on or off the printer. How to turn on the printer While the printer is off, hold down the POWER button for a few seconds. When "ONLINE" is displayed on the LCD, the printer is ready. How to turn off the printer Hold down the POWER button until the LCD goes off.
(11)	[FEED] button	Feeds media or reprints a previously printed data. Function of the [FEED] button differs depending on the issue mode.
(12)	[PAUSE] button	Temporarily stops media issue or restarts printing. Used to recover the printer after clearing an error.

Loading a battery pack

WARNING!

1. If the battery pack leaks liquid or gives out smoke or bad smell, immediately stop using it and keep it away from fire. Failure to do this may cause an explosion or a fire.
2. In the United States, used lithium ion batteries should be returned to the store where you bought the machine. (USA only)
3. LITHIUM ION BATTERY DISPOSE OF PROPERLY
Caution: Do not handle damaged or leaking lithium ion battery.
4. To avoid injury, be careful not to drop the battery pack on your foot.

Press the Battery Lever to open the Battery Cover, insert the Battery Pack fully into the printer. The Battery Pack is locked in by the Battery Cover. Be careful of the orientation of the Battery Pack.

NOTE:

- Be sure to use only the battery pack designed and manufactured for use with the printer B-FP3D series Battery Pack:

B-FP803-BT-R (for B-FP3D-GS series)

B-FP803-BTH-QM-R (for B-FP3D-GH series)

- When unpacked, the battery level of the supplied Battery Pack is not full. Please charge the Battery Pack with an optional Battery Charger or load the Battery Pack in the printer and connect an optional adapter before using it.

- ◆ Single-slot Battery charger: B-EP800-CHG-QM-R
- ◆ 6-slot Battery Charger: B-EP800-CHG6-QM-R
- ◆ AC Adapter: B-EP800-AC-QM-R
- ◆ Cigarette lighter adapter: B-EP802-DC12-QM-R
- ◆ DC adapter: B-EP800-DC48-QM-R
- ◆ DC Jack plug adapter: B-FP800-DCJA-QM-R

CAUTION!

DO NOT CONNECT any device other than the above to the printer.

[B-FP3D Series]

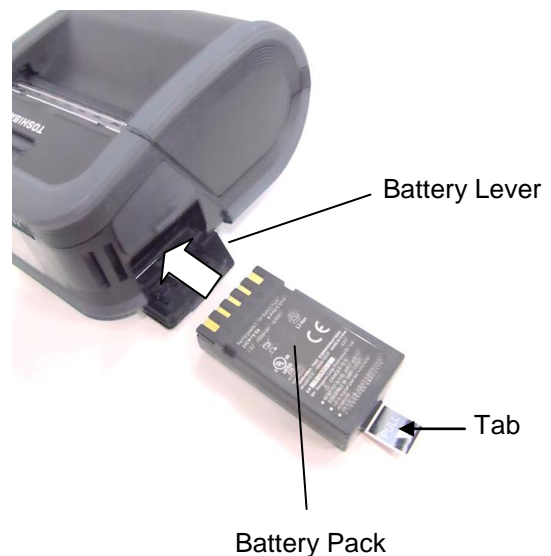

Removing a battery pack

Push the Battery Lever down in the direction of the arrow, and remove the Battery Pack from the printer by pulling on the tab.

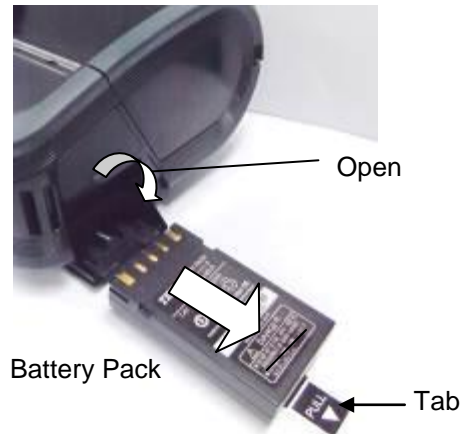
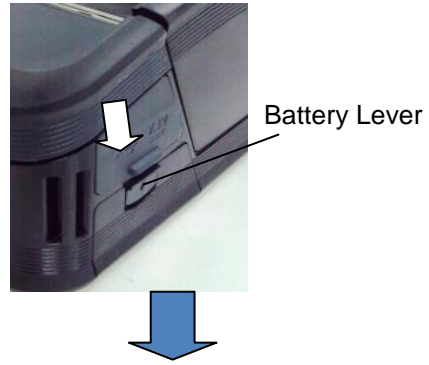

Charging the Battery Pack with an Optional Adapter

When charging the battery pack in the printer using an optional AC Adapter, cigarette lighter adapter, or DC adapter, insert the plug of the adapter into DCIN Connector of the printer.

NOTE:

For details, please refer to the Owner's Manual of respective optional adapters.

When using an optional battery charger to charge the battery packs, please refer to the Owner's Manual of respective models of battery charger.

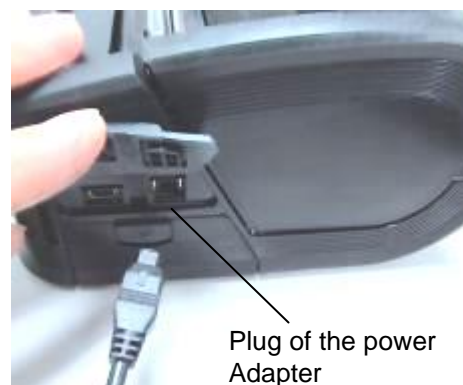

Loading the Media

1. Push the Top Cover Open Button to open the Top Cover.

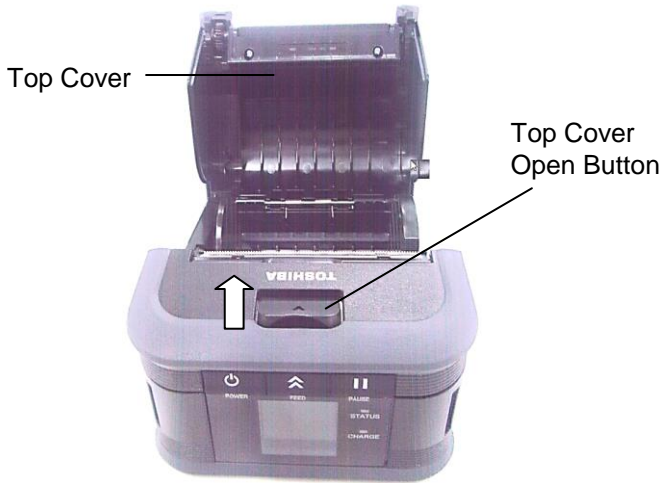

CAUTION!
The Print Head becomes hot immediately after printing, allow it to cool before loading the media.

2. Move the Paper Guide Lever toward the Operation Panel and the Paper Guides outward.

NOTE:
Do not move the Paper Guides without unlocking the Paper Guide Lever. Doing this may break the Paper Guide.

3. Place a media roll in the printer. Only outside wound media can be used in the printer.



NOTE:
Use caution when working with the Tear bar. The edge is sharp.

4. Adjust the Paper Guides to the media roll width.
5. Push back the Paper Guide Lever to lock the Paper Guides.

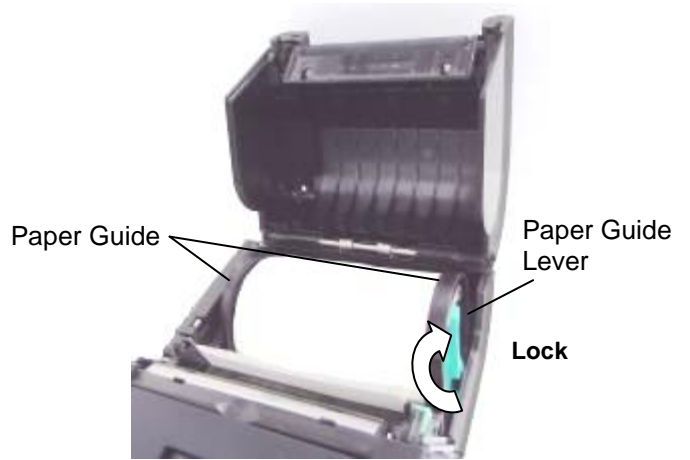

6. Pull the top edge of the media toward the Operation Panel, and close the Top Cover removing slack of the media.

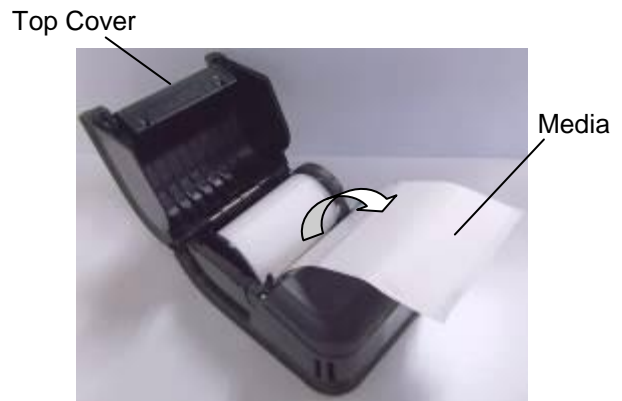

NOTE:

- Please use TOSHIBA TEC approved media only. Toshiba TEC is not responsible for any print result caused by use of other media
- When you order media, please contact the nearest TOSHIBA TEC representative.

Before using a peel-off unit (GH30, GH40 models only)

When issuing labels in the peel-off mode, pull out the peel-off roller before loading a label roll.

1. Open the Top cover, and push the lock lever in the direction of the arrow.

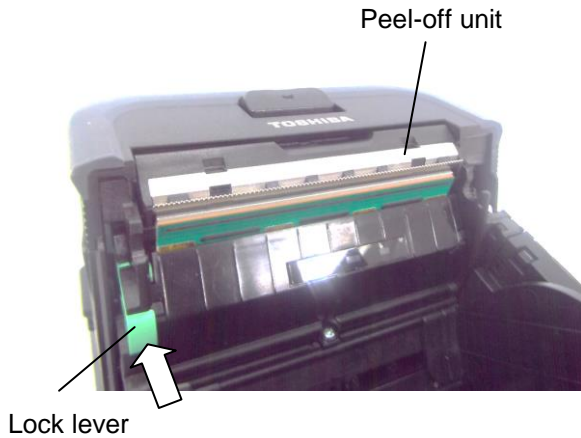

2. This will pop-up the Peel-off Unit. Refer to "Loading the Media" on the previous page and set a label roll.



NOTES:

1. *DO NOT PULL* the center of the Peel-off roller hard. Doing so may break the Peel-off roller.
2. Do not forcibly pull out the Peel-off roller or push it into the printer, otherwise the Peel-off roller may break.
3. Use caution when working with the Tear bar. The edge is sharp.

■ How to put away the Peel-off Roller

1. Gently press the Peel-off Roller Unit down, and push it into the printer in the direction indicated by the arrow until it clicks.

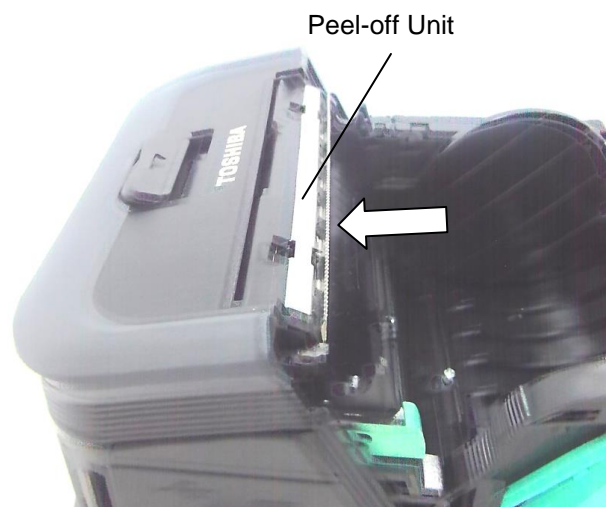
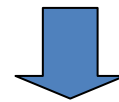

How to attach the accessories

CAUTION!

1. Care should be taken not to drop the printer when securing it to your waist or slinging it over your shoulder.
2. For fixing the printer to your belt, the belt width should be 40 mm or less. Use of the other belts may cause the printer to fall off.

■ Belt Clip

When you want to use the printer on belt, first secure the supplied Belt Clip to the rear of the printer.

1. Secure the Belt Clip to the printer back with the two screws.

NOTE:

Only use the supplied screw to secure the Belt Clip. Use of other screw may damage the inside of the printer.

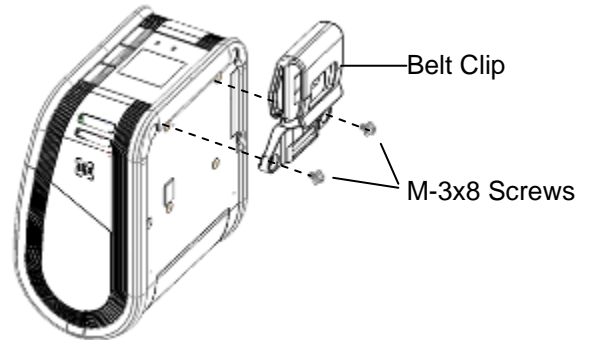

2. Fasten the Belt Clip to your belt.

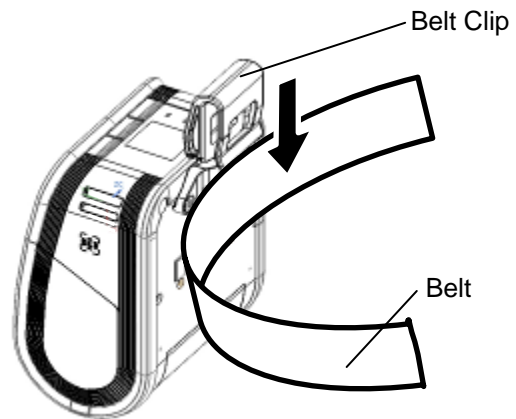

■ Shoulder Strap (Option)

Use the following procedure to fasten an optional shoulder strap (B-EP900-SS-QM-R) to the printer.

1. Pass either end of the Shoulder Strap through the strap slot on the front of the printer.
2. Pass the end of the Shoulder Strap through the buckle. Slide the buckle to adjust the length of the Shoulder Strap.
3. Repeat for the other end of the Shoulder Strap.

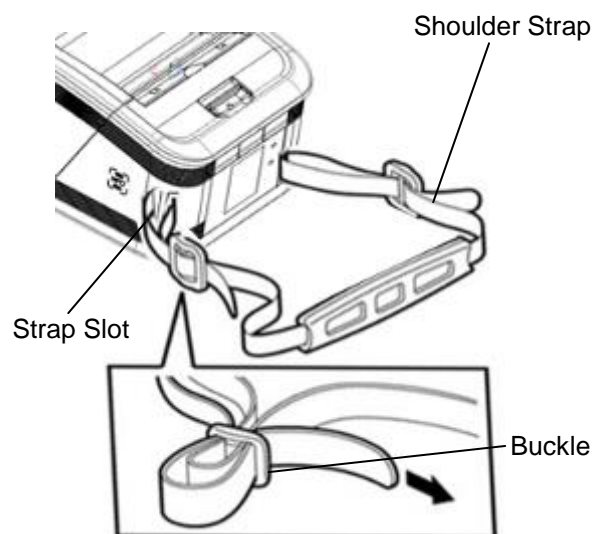

Data Transmission

■ USB

1. Turn on the host and start the system.
2. Turn on the printer and connect a USB cable to the printer.
3. Connect the USB cable to the host.
4. Send data from the host to the printer.

NOTE:

- For details of the interface cable, please consult the nearest TOSHIBA TEC representative.
- When disconnecting the USB cable, please follow the instructions of the host system.

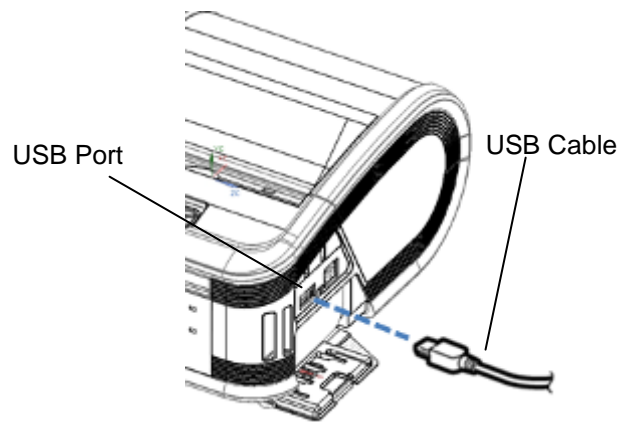

■ Wireless

1. When using Bluetooth, ensure the printer within 3m of the host.
In the case of wireless LAN, place the printer within a wireless coverage area.
2. Turn on the printer and the host, and send data from the host to the printer.

NOTE:

- Please be sure to read "Precautions for Handling of Wireless Communication Devices" before operating the printer.
- Confirm that there are no obstacles between the printer and the host. Obstacles may cause a communication failure.

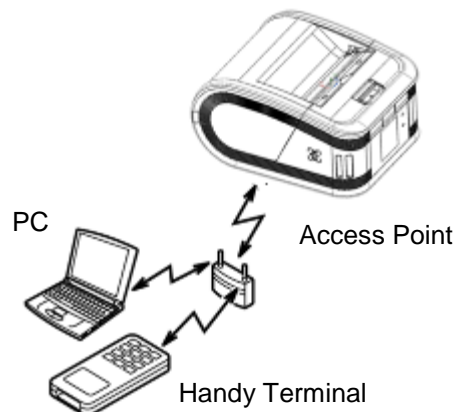
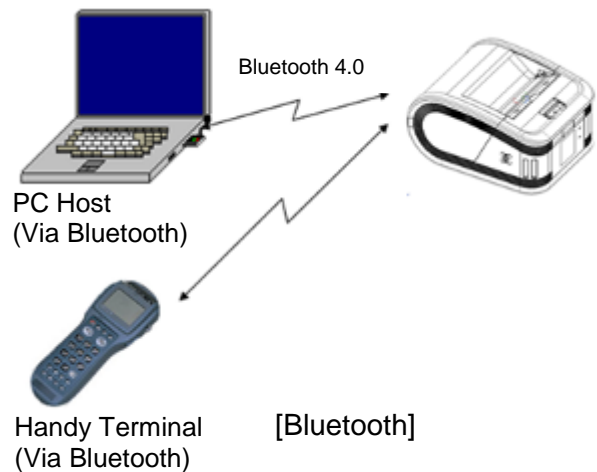

The radio connectivity is affected by the operating environment. Especially, metal obstacles, metal powder, or locations enclosed by metal walls may prevent proper communication. For the installation location of access points, please consult the nearest TOSHIBA TEC representative.

Daily maintenance

To help retain the high quality and performance of your printer, it should be cleaned regularly.

CAUTION!

- *DO NOT USE a sharp object to clean the print head or various rollers, as this may cause a print failure or breakdown of the printer.*
- *NEVER USE any volatile solvent including thinner and benzene, as this may cause a print failure or breakdown of the printer.*
- *Do not touch the print head element with bare hands, as a static discharge may damage the print head.*
- *The print head becomes hot immediately after printing. Allow it to cool before performing any maintenance.*

■ Print head

Wipe the print head element with a print head cleaner pen.

When linerless labels are used, wipe off dirt of residual glues from the Print head after the use of one or two media rolls.

NOTE:

Use caution when working with the Tear bar. The edge is sharp

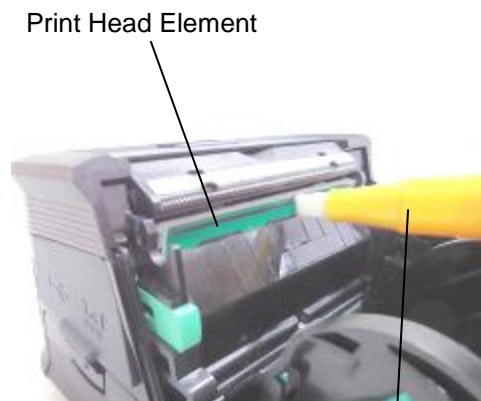

Print Head Cleaner Pen

■ Platen and strip shaft

Wipe clean the platen with a soft cloth slightly moistened with absolute ethyl alcohol, while rotating the platen.

Wipe clean the strip shaft with a soft cloth slightly moistened with absolute ethyl alcohol

Clean the platen of the linerless label kit in the same way. Cleaning should be performed after the use of one or two media rolls.



■ Media Sensor Window and Media Path

Remove dust or dirt from the Media Sensor Window with a commercially available soft, dry brush.

Wipe clean the Media Path with a soft dry cloth.

When linerless labels are used, wipe off dirt of residual glues from the Media Guides after the use of one or two media rolls.



■ Top Cover and Operation panel

Wipe clean the cover and operation panel window with a soft dry cloth slightly moistened with absolute ethyl alcohol.

Remove any dirt or residual glues from the media outlet with a cotton swab slightly moistened with absolute ethyl alcohol.

When linerless labels are used, wipe off dirt of residual glues from the Top Cover or Media Outlet after the use of one or two media rolls.

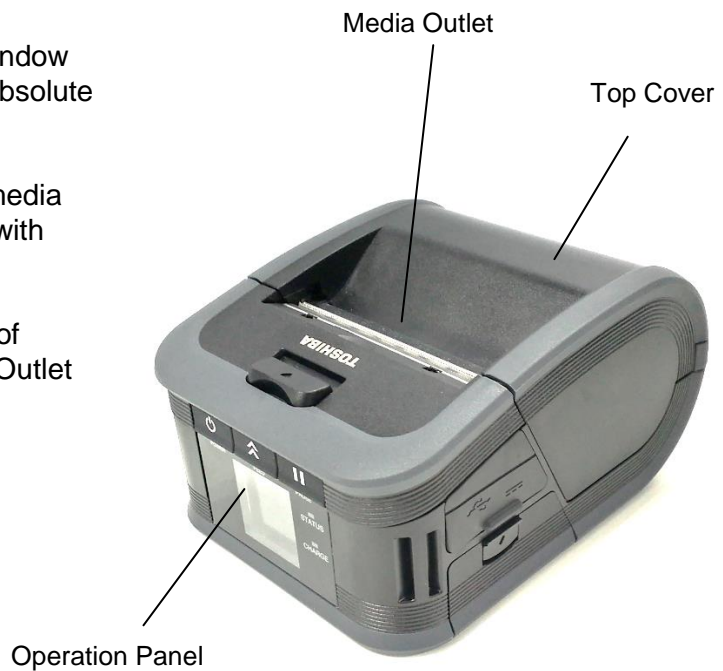

Troubleshooting

When a problem occurs during operation, please check the following troubleshooting guide and take the corrective action suggested.

If you cannot solve a problem with the following solutions, do not attempt to repair it by yourself. Turn off the printer, remove the battery pack, then contact a TOSHIBA TEC service representative for assistance.

If an error message is displayed.

When an error message is displayed, follow the respective instruction, then press the [PAUSE] button. The error will be cleared.

Error Message	Cause	Solution
COMMS ERROR	A parity error or framing error has occurred during communication.	Turn the power off, then back on. Send data from the host to the printer again. If the problem recurs, please turn off the power and contact TOSHIBA TEC service representative.
PAPER JAM	The media is not correctly loaded.	Load the media correctly.
	The media has jammed in the printer.	Remove the jammed media, and load the media correctly. Press the [PAUSE] button.
	The media has not fed correctly.	Load the media correctly and press the [PAUSE] button.
	The reflective sensor does not detect black marks.	Load the correct media with black marks and press the [PAUSE] button.
	The transmissive sensor does not detect gaps between labels.	Load the correct media. If the problem recurs, set a threshold.
NO PAPER	The printer ran out of media.	Load a new media roll and press the [PAUSE] button.
COVER OPEN	The top cover is opened.	Close the top cover.
HEAD ERROR	A part of the print head element is broken.	Turn off the printer and contact TOSHIBA TEC service representative for replacement of the print head.
FLASH WRITE ERROR	A flash memory write error occurred.	Turn the power off, then back on. Send data from the host to the printer again. If the problem recurs, please turn off the power and contact TOSHIBA TEC service representative.
FORMAT ERROR	A flash memory format error occurred.	Turn the power off, then back on. Send data from the host to the printer again. If the problem recurs, please turn off the power and contact TOSHIBA TEC service representative.

Error Message	Cause	Solution
FLASH MEMORY FULL	The flash memory has insufficient area for storing data.	Turn off the [POWER] button, then back to on. Re-format the memory to free up space then send data from the host to the printer again. If the problem recurs, please turn off the power and contact TOSHIBA TEC service representative.
LOW BATTERY	Remaining battery capacity is low.	Turn off the printer, and replace the battery pack with a fully charged one.
EXCESS HEAD TEMPERATURE	The print head temperature reached the upper limit of the operating temperature.	Stop printing and wait until the printer automatically restores. If the problem recurs, please turn off the power and contact TOSHIBA TEC service representative.
AMBIENT TEMP ERROR	The ambient temperature reached the upper limit of the operating temperature.	Stop printing until the ambient temperature falls within the printer's operating temperature range.
BATTERY TEMP ERROR	The battery is extremely hot.	Turn off the printer, disconnect the power adapter if connected, and wait until the battery temperature falls within the printer's operating temperature range.
HIGH VOLT. ERROR	The battery voltage is abnormal.	Turn off the printer, remove the battery, reload it, and turn on the printer again. If the problem recurs, please turn off the power and contact TOSHIBA TEC service representative.
CHARGE ERROR	An error was detected while charging the battery.	It could be the end of battery life. Replace the battery pack with a new one.
Command error example PC001;0A00,0300,	When a command error occurs, up to 16 digits of alphanumeric or symbol is displayed on the upper line of the LCD.	Turn off the printer, then back on. Send data from the host to the printer again. If the problem recurs, please turn off the power and contact TOSHIBA TEC service representative.
Other error messages	A hardware or software failure occurs.	Turn off the printer, then back on. If the problem recurs, please turn off the power and contact TOSHIBA TEC service representative.

***: The number of unprinted labels 1 to 9999 (in units of label)

When the printer does not operate properly

In the case of the following symptoms, please check the respective points and take corrective action.

Symptom	Point to check (Cause)	Solution
The printer does not turn on by pressing the POWER switch.	The battery pack is not loaded correctly.	Load a fully charged battery pack.
Fully charged battery is loaded but the operating time is short.	The battery life is expired.	Load a fully charged new battery pack
The printer cannot communicate via USB.	The printer is not turned on.	Turn on the printer.
	The printer is communicating via wireless communication.	Terminate the wireless communication
	Issue mode is incorrect.	Select a correct issue mode.
The printer cannot communicate via Bluetooth. (GS30/GH30 only)	The printer is not turned on.	Turn on the printer.
	Distance to the host is too far.	Bring the printer to within 3m of the host.
	The printer is used in a location where it is subjected to noise or interference.	Avoid such location.
	The printer address is not correctly set on the host.	Set the correct printer address on the host.
	Issue mode is incorrect.	Select the correct issue mode.
The printer cannot communicate via wireless LAN. (GS40/GH40 only)	The printer is not turned on.	Turn on the printer.
	Distance to the host is too far.	Bring the printer within a wireless coverage area.
	Obstacles block the radio wave.	Use the printer in a location with no obstacles.
	The printer is used in a location where it is subjected to noise or interference.	Avoid such location.
	The printer address is not correctly set on the host.	Set the correct printer address on the host
	Channel setting for the access point or host is incorrect.	Avoid using a channel which interferes with adjacent access points.
	Issue mode is incorrect.	Select the correct issue mode.
Printout is too light. The printer received print data but does not print.	The print head is dirty.	Clean the print head.
	The media is not loaded properly.	Load the media properly.
	The media used has deteriorated past its use date.	Load a new media roll.
	The media is not a TOSHIBA TEC approved one	Use TOSHIBA TEC approved media.
The printer received print data but does not print.	The STATUS lamp is lit or blinking.	Clear the error
	The media is not loaded correctly.	Load the media correctly.

Printer Specification

Model	B-FP3D-GS30-QM-R	B-FP3D-GS40-QM-R	B-FP3D-GH30-QM-R	B-FP3D-GH40-QM-R
Media types	Label / Tag / Receipt			
Print method	Direct Thermal			
Resolution	203dpi (8dots/mm)			
Print speed	Max 6 inch/s (152 mm/s) (It depends on the operating environment, print conditions, battery condition, etc.)			
Effective print width	72mm (2.9")			
Issue mode	Batch		Batch / Peel-off	
Barcode	UPC-A/E, EAN8/13,UPC-A/E add on 2&5, EAN-8/13 add on 2&5, Code39, Code93, Code128, EAN128, NW7, MSI, Industrial 2 of 5, ITF, Postnet, RM4SCC, KIX-code, GS1 Databar			
Two Dimensional Code	Data Matrix, PDF417, Maxicode, QR code, Micro PDF417, Micro QR, GS1 Data Matrix			
Font	Bitmap: Alpha numeric 25types, Simplified Chinese 24x24(GB18030), Japanese gothic 16x16, 24x24, mincho 32x32 Outline: 5types Open Type Font: Noto Hans Sans (CJK)			
LCD	TFT Color LCD, 128x128dots with Backlight			
Battery	7.4V 2500mAh Li-Ion battery		7.2V 2500mAh Li-Ion battery	
Dimension	116 (W) x 150 (D) x 80 (H) mm (Excluding the project parts)			
Weight (with battery)	650g		660g	
Operating temperature	-15°C to 50°C (5°F to 122°F)			
Operating humidity	25~85% RH (No condensation)			
Charging temperature	AC adapter: 0°C to 40°C (32°F to 104°F)			
Memory	Flash ROM: 64MB, SDRAM: 16MB		Flash ROM: 64MB, SDRAM: 32MB	
Interface	Bluetooth 4.0 (Bluetooth Smart Ready: BR/EDR, BLE)	Wireless LAN (802.11b/g/n)	Bluetooth 4.0 (Bluetooth Smart Ready: BR/EDR, BLE)	Wireless LAN (802.11b/g/n)
	USB 2.0 (Full Speed)			
NFC	ISO/IEC14443 Type A, NFC Forum Type2, 144bytes			
Media sensors	Label gap Black mark Paper end		Label gap Black mark Paper end Peel-off	
Option	1-slot battery charger (B-EP800-CHG-QM-R) 6-slot battery charger (B-EP800-CHG6-QM-R) AC adapter (B-EP800-AC-QM-R) Cigarette lighter adapter (B-EP800-DC12-QM-R) DC adapter (B-EP800-DC48-QM-R) Shoulder strap (B-EP900-SS-QM-R) Spare battery: B-FP803-BT-R (for B-FP3D-GS series) B-FP803-BTH-QM-R (for B-FP3D-GH series)			

Media Specification

<Labels>

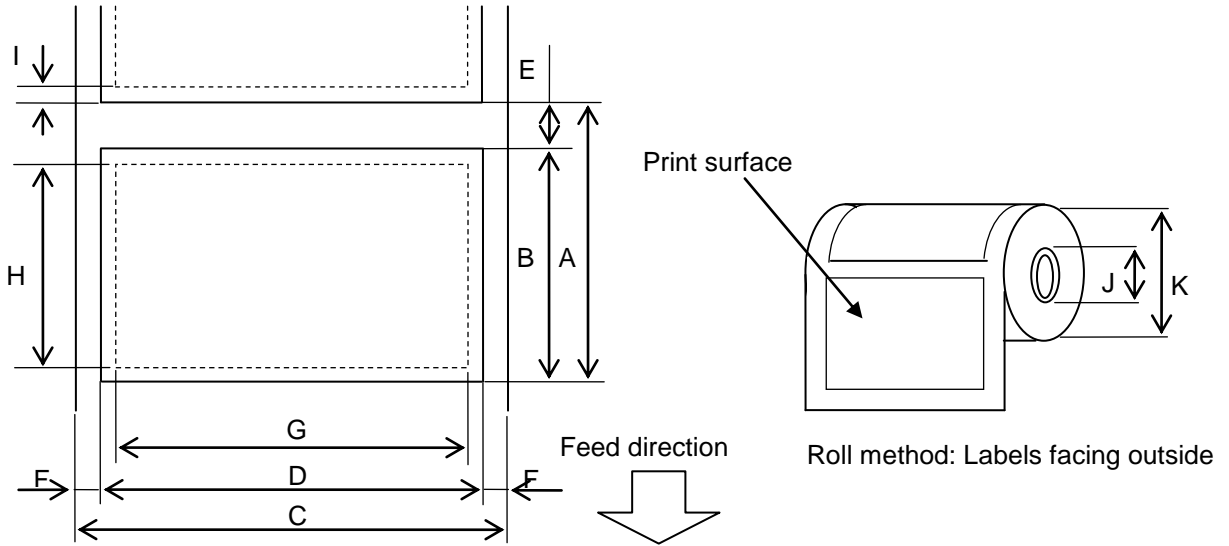

<Tag>

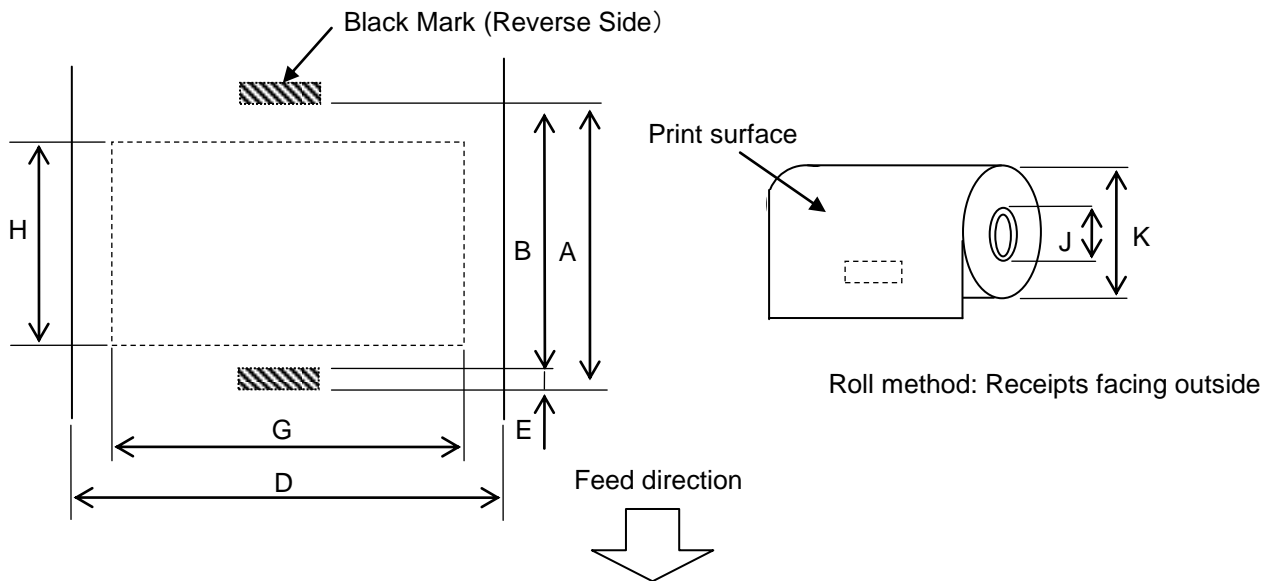

Item		Media type	Label		Receipt	
		Mode	Batch	Strip	With black marks	Without black marks
A	Label pitch	Min.	10.0	13.0	10.0	–
		Max.	999.9	67.0	999.9	–
B	Label length	Min.	7.0	10.0	7.0	–
		Max.	997.0	60.0	997.0	–
C	Backing paper width	Min.	26.0		–	
		Max.	80.0		–	
D	Label width	Min.	24.0		–	
		Max.	78.0		–	
D	Media width	Min.	–		24.0	
		Max.	–		80.0	
E	Label-to-label gap	Min.	3.0		–	
		Max.	7.0		–	
E	Black mark length	Min.	3.0	3.0	3.0	–
		Max.	7.0	7.0	7.0	–
F	Vertical gap width	Min.	1.0	1.0	–	–
		Max.	7.0	7.0	–	–
G	Effective print width	Max.	72.0			
H	Effective print length	Min.	5	8.0	5	–
		Max.	995.0	58.0	995.0	–
I	Unprintable area	1.0 from the upper/lower label edge				–
J	Outer diameter of paper core	Min.	Φ12.0 +0/-0.5		Φ12.0 +0/-0.5 (No paper core: Φ18)	
K	Outer roll diameter	Max.	Φ67.0 +0/-1.0			
	Roll direction	Outside only				

CARE/HANDLING OF THE MEDIA

CAUTION!

Be sure to read carefully and understand the Supply Manual. Use only media that meets specified requirements. Use of non-specified media may shorten the head life and result in problems with bar code readability or print quality. All media should be handled with care to avoid any damage to the media or printer. Read the following guideline carefully.

- Do not store the media for longer than the manufacturer's recommended shelf life.
- Store media rolls on the flat end, do not store them on the curved sides as this might flatten that side causing erratic media advance and poor print quality.
- Store the media in plastic bags and always reseal after opening. Unprotected media can get dirty and the extra abrasion from the dust and dirt particles will shorten the print head life.
- Store the media in a cool, dry place. Avoid areas where they would be exposed to direct sunlight, high temperature, high humidity, dust or gas.
- The thermal paper used for direct thermal printing must not have specifications which exceed Ca++ 800 ppm, Na+ 800 ppm, K+ 800 ppm and Cl- 600 ppm.
- Some ink used on pre-printed labels may contain components which shorten the print head's product life. Do not use labels pre-printed with ink which contains hard substances such as carbonic calcium (CaCO₃) and kaolin (Al₂O₃, 2SiO₂, 2H₂O).

For further information please contact your local distributor or your media manufacturer.